

Ci50 SOUNDlight™ System

Information Sheet

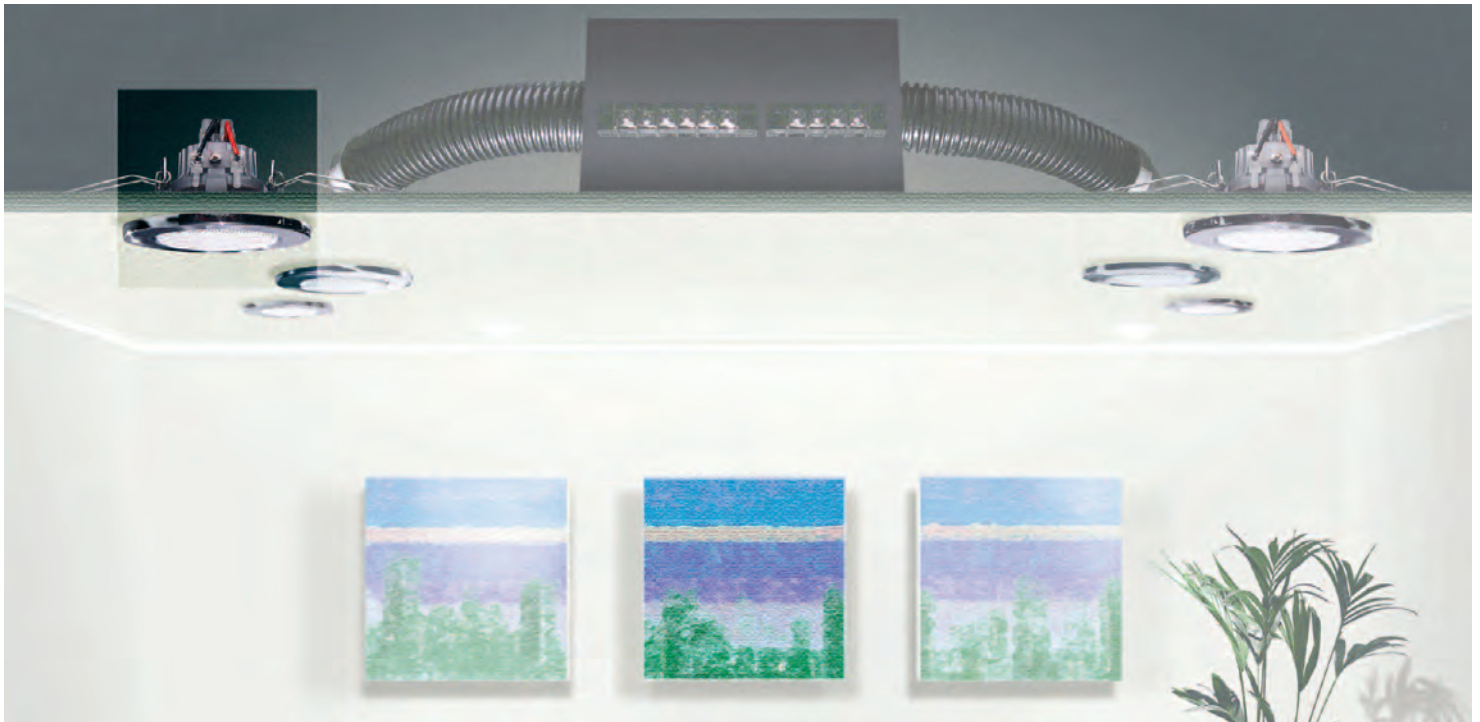

Loudspeaker installations don't come more discreet than the Ci50 Soundlight System. A full bandwidth sound system consisting of four satellite speakers and a twin-ported subwoofer, the only visible components are designed to be virtually indistinguishable from a standard 50mm low voltage light fitting once installed. The subwoofer itself is hidden out of sight in the ceiling void, with a 100mm (4") dual

coil bass driver pumping sound into the room via two ingenious flexible ports. There's nothing discreet about the way it performs, though - by combining high quality drivers with innovative KEF engineering, response is fluid and accurate across the frequency range and the sound image has astonishing clarity and power for the speaker size.

Features and Benefits:

The Ci50 Soundlight System combines 10-100W per channel power handling and 88dB sensitivity, for a maximum in-room SPL of 92dB. The Ci50 Soundlight System is purpose-built for flush mounting into walls and ceilings. The Ci50R speakers are mounted with KEF's standard lighting style fitting. It is available in White, Chrome, Brass or Brushed Steel bezels. The Ci50SW subwoofer is ceiling mounted by using the joist or suspended ceiling brackets included.

Ci series

custom installation speakers

KEF Audio (UK), Eccleston Road, Tovil, Maidstone, Kent, ME15 6QP U.K. Telephone: + 44 (0) 1622 672261. Fax: + 44 (0) 1622 750653

KEF America, 10 Timber Lane, Marlboro, New Jersey, 07746 USA. Telephone: + 1 732 683 2356. Fax: + 1 732 683 2358

GP Acoustics GmbH, Heinrichstraße 51, D-44536 Lünen, Deutschland. Telephone: +49 (0) 231 9860-320. Fax: +49 (0) 231 9860-330.



www.kef.com

www.kefamerica.com

www.kefaudio.de

Ci50 SOUNDlight™ System

Installation

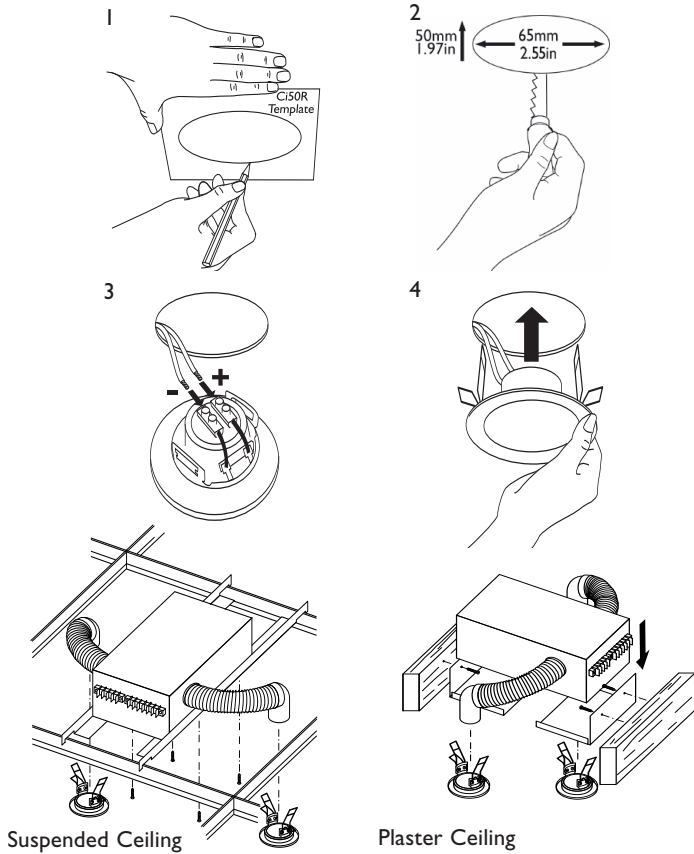

Polar graphs

500Hz

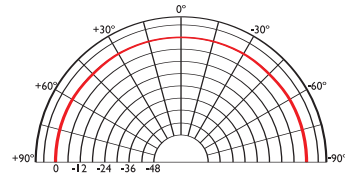

1kHz

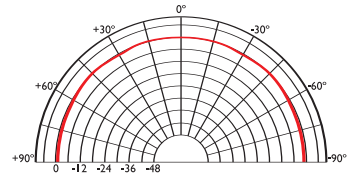

2kHz

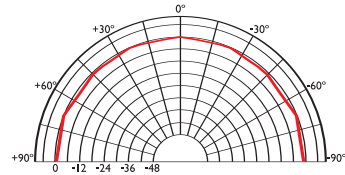

4kHz

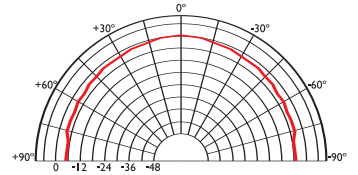

8kHz

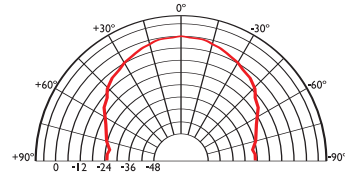

16kHz

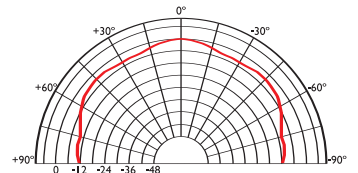

Architectural specifications:

The Ci Series Ci50 Soundlight System comprises four satellite Ci50R 50mm full range speakers and a band pass, dual ported Ci50SW subwoofer with a 100mm, dual coil bass unit, and passive crossovers, for in-ceiling void installation.

System performance should meet or exceed the following criteria: frequency response 1 metre on-axis with swept sinewave shall be 62Hz to 20kHz, system sensitivity shall be at least 88dB for 2.83V@1m, both channels driven. The system impedance shall be 4 ohms.

The Ci Series Ci50 Soundlight System is best suited where high quality background music and speech reinforcement applications require hi-fi performance such as:

- Multi Room systems.
- Lounges, Bars, Boutiques.
- Boardrooms & Offices.

Frequency / Power response, Input impedance

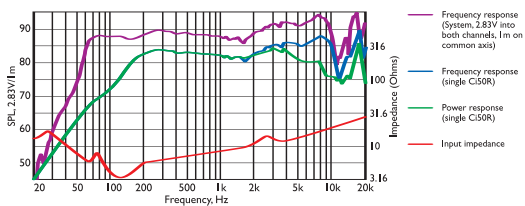

Directivity Index / Beamwidth

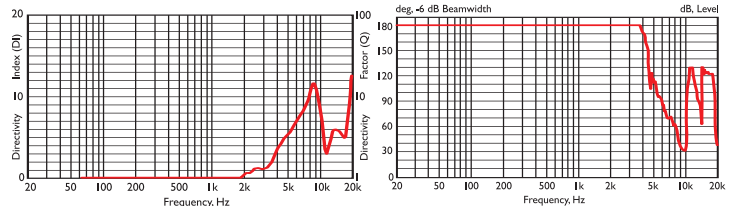

Specifications

Frequency range	62Hz - 20kHz
Sensitivity (2.83v @ 1m)	88dB
Rec. amplifier power	10 - 100W
Nominal Impedance	4Ω (min. 3.2Ω)
Crossover Frequency	220Hz

Enclosure material (Subwoofer)	MDF
Terminals	terminal blocks up to Ø2.5mm (0.1") conductor
Dimensions (Full range)	Ø80 x 55 mm deep, Ø3 x 2.25 in. deep
(Subwoofer H x W x D)	342 x 180 x 104 mm, 13.5 x 7 x 4 in.
Net weight	4.14kg (9.1lbs) (System)